

Multistar LX-24

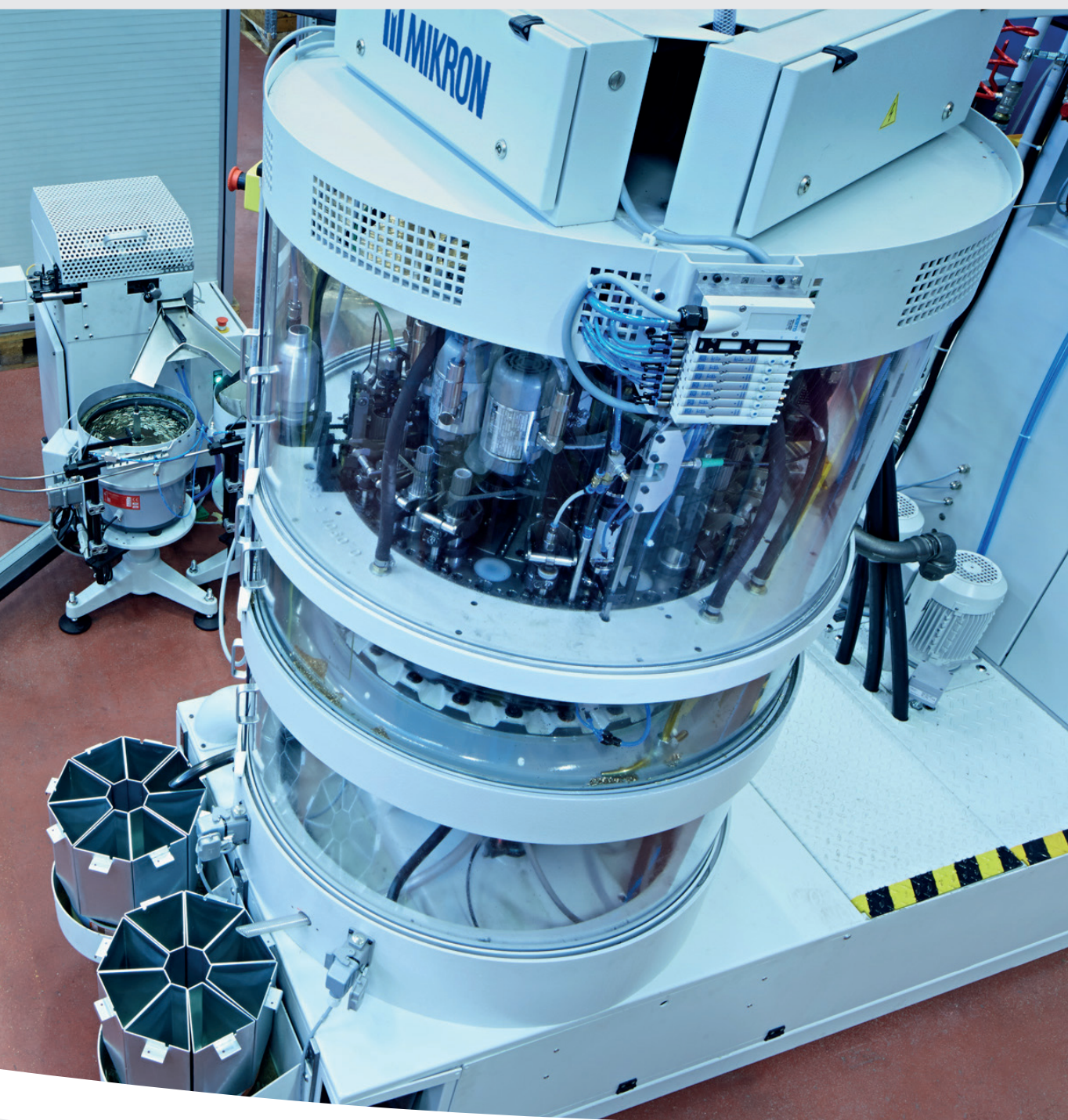

The high volume professional

Mikron Multistar LX-24

For quantity with quality!

The transfer system Multistar LX is a processing system for manufacturing small precision parts in large quantities. Versions with 24 work stations are available. What makes the Multistar LX so special? It's the fast, nimble and precise performance and its simple and functional construction, which make the Multistar LX your reliable partner. Ideally, but not a necessity, is an output of at least a million parts per year. Another advantage is the price performance ratio, which makes the Multistar an investment with added value.

As fast as it gets!

The mechanical control beats anything. Perfectly coordinated accelerations and feeds provide speed. The mechanism works as follows: A master cam controls with the help of a rocker arm the feeding and processing track of the working spindles. A frequency regulated motor drives the working spindles in pairs over a toothed belt. Driven together, both of the spindle pairs remain speed independent. Incomparable processing speed means economical mass production.

At home in many places

The Multistar LX is used for electrical and electronic contacts, plug-in connections for light wave conductors, nozzles, valves and ballpoint pen tops or for workpieces used in the medical technology. When it comes to high volume production, Multistar is the best partner.

Advantages at a glance

- High processing speed
- Absolute reliability
- High operating convenience
- Minimal maintenance required
- Convincing price-performance ratio

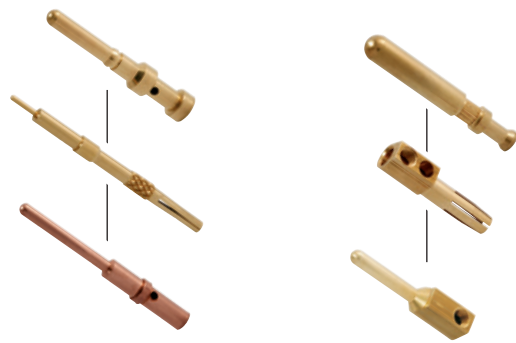

Typical Multistar LX workpieces

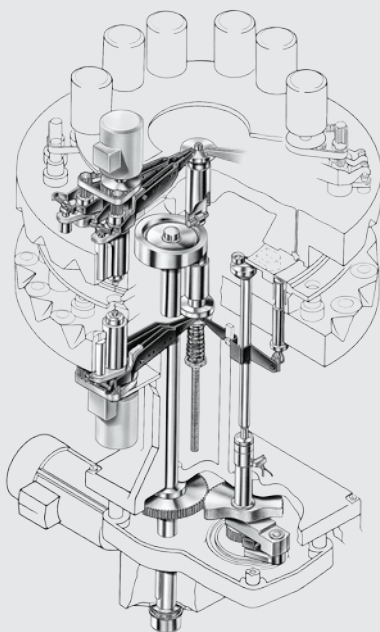

Interaction of master cam, rocker arm, motors and working spindles



Turning of the workpiece

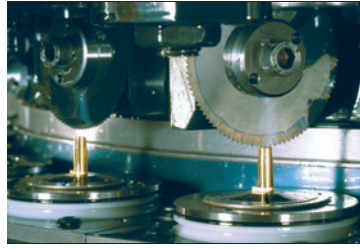

Milling of slots

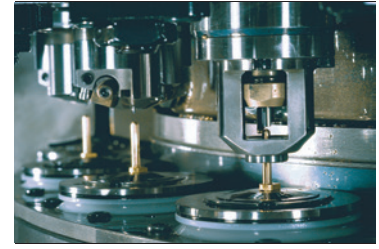

Processing with guiding bush

Multistar LX-24: It's a professional, isn't it?

The Multistar LX-24 with 24 work stations and up to 44 working spindles is the guarantor for a smooth mass production. With the Multistar LX-24 machining is possible from below and above or from the side, for example when separating, drilling, turning or thread cutting. Other additional features are the 24 intermediate stations, which allow measuring, controlling and cleaning procedures during the same run.

That way you can quadruplicate your productivity

It is unique! A run produces up to 600 simple workpieces per minute. Separating the fields of work doubles, triples or quadruplicates the amount of production at the same high processing speed. With the same parallel-concept, the complete production of different workpieces is possible within one run.

Factors of success at one glance

- Fastest rotary transfer machine worldwide
- High precision and repeatability
- Simultaneous machining at two sides at each station
- Multiple cycles for extremely high amounts
- Parallel production of two parts (e.g. plug and socket)
- Load and unload time parallel to the machining process
- Quick and simple tool changes



Multistar LX-24/1000

Multistar LX-24 – What do you gain when separating the field of work? The simultaneous production of plugs and sockets in one run.

One run – two workpieces

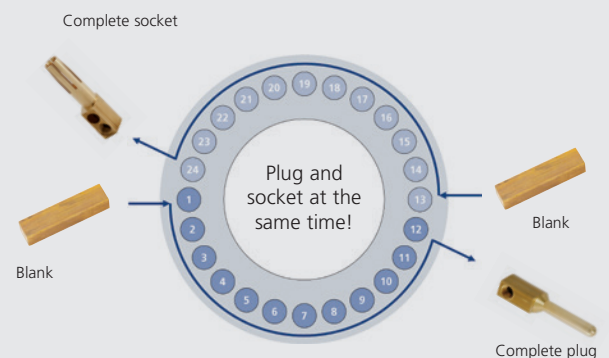

Mikron Multistar LX-24

Typical applications

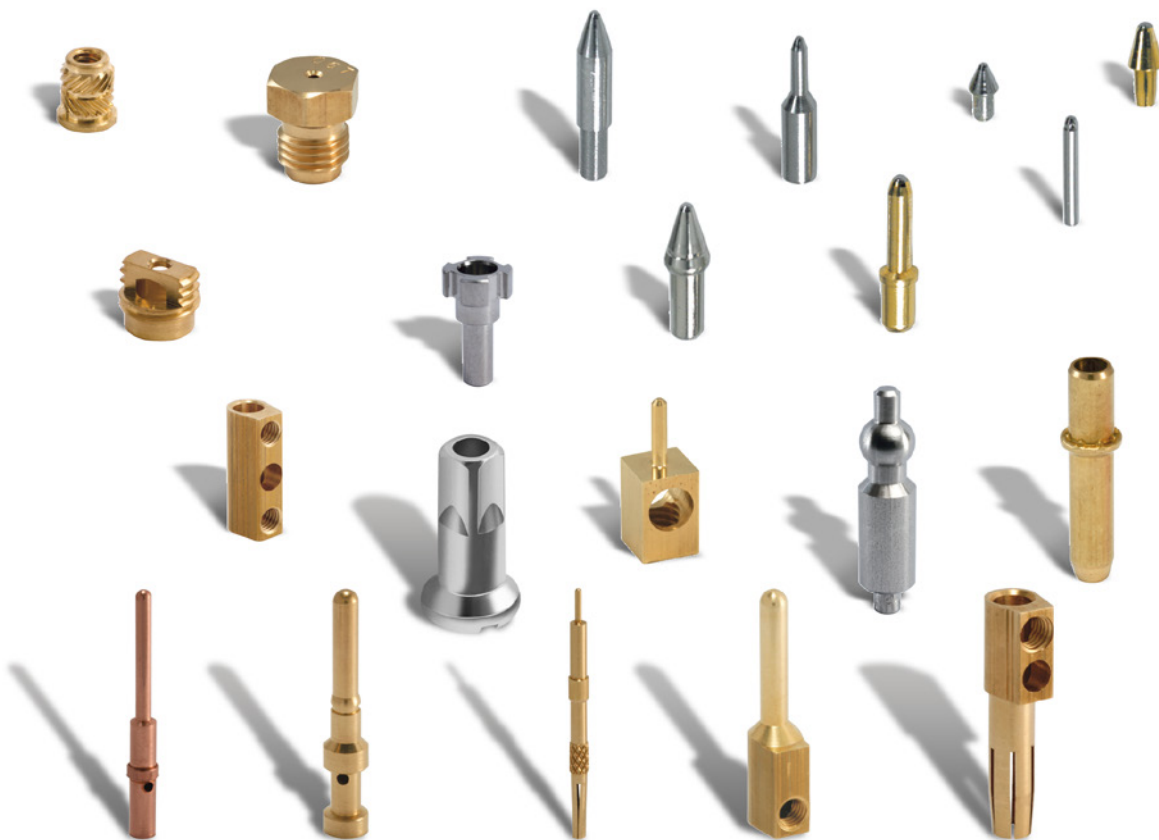

Typical Mikron LX-24 workpieces

CASE HISTORY Bicycle Nipples

On Mikron Multistar LX-24

The challenge

- Produce bicycle nipples \varnothing 4mm, length 12mm, thread length 8mm
- Annual production volume approx. 100 mio nipples
- Material: Brass

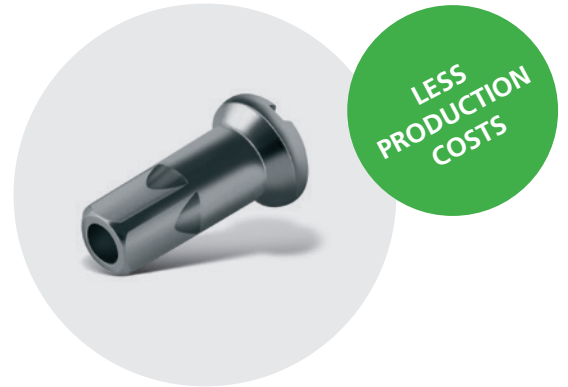

The traditional solution

Production area: **25 m²**



Required machines: **4***



Necessary statistic control: **4**



Necessary tools: **24**



Employees: **1 every 4 machines**



- Raw material: starting from pressed blanks

* Traditional transfer machines

Mikron: The innovative solution

Production area: **16 m²**



Required machines: **1 Mikron Multistar LX-24**



Necessary statistic control: **1 for constant quality**



Necessary tools: **20**



Employees: **0.25/machine**

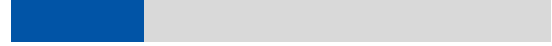

- Raw material: starting from pressed blanks

Your advantage

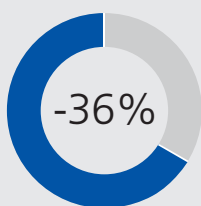

Production area

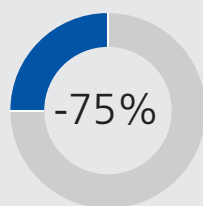

Machines

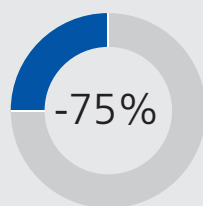

Employees

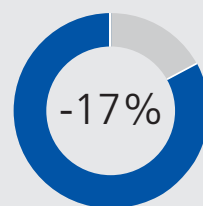

Setup time

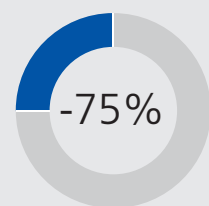

Productivity

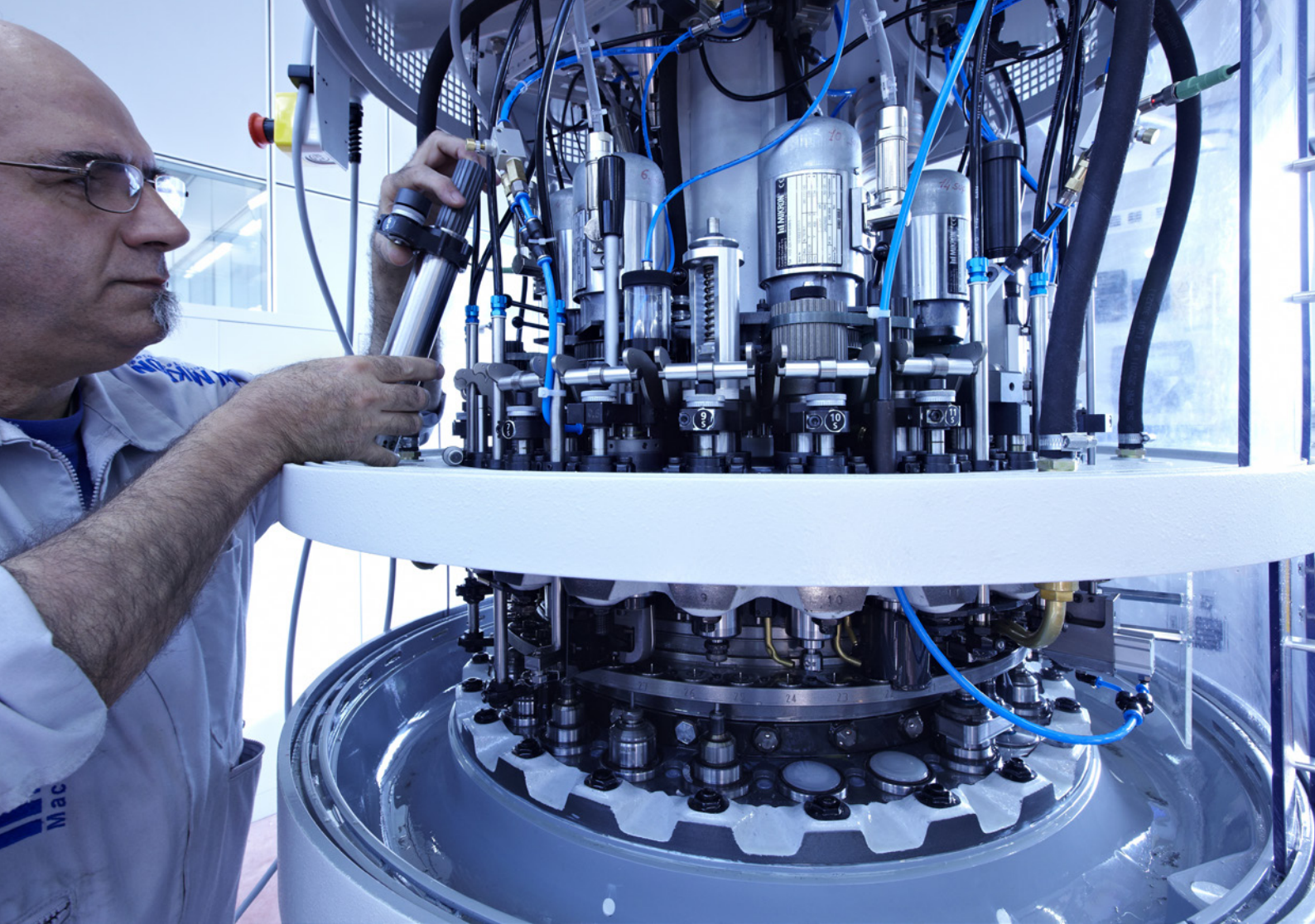

Technical data Multistar LX-24



Machine		LX-24/1000	LX-24/1500/ LX-24/1500R
Number of stations		24	24
Max. number of upper units ¹⁾		24	24
Max. number of lower units ¹⁾		22	22
Max. number of lateral units ¹⁾		0	22
Number of clamping fixtures		24 / 48	24 / 48
Table indexing accuracy TIR	mm	0.005	0.005
Max. cycles	pcs/min.	120	140
Double cycle	pcs/min.	2 x 120	240
Multiple cycle	pcs/min.	4 x 120	500
Clamping devices			
Min. clamping diameter	mm	0.4	0.4
Max. clamping diameter	mm	10	10
Machining units			
Max. machining length	mm	35	35
Central cam for working feed (machining units)		yes	yes
Linear cam for working feed (machining units)		no	no
CN-control system for working feed		no	no
Chuck indexing for workpiece machining around	360°	no	no
Rotation of workpiece (chuck drive), speed adjustable up to 6000	rpm	no	no
Machining spindles			
Spindle speed	rpm	22'000	22'000
Spindle diameter		40	40
Max. spindle rating	kW	0.2	0.2
Installation			
Main drive power	kW / Hz	2.2 / 50	2.2 / 50
Input voltage ²⁾	V	400	400
		3 phases	3 phases
	Hz	50/ 60	50/ 60
Power consumption ca. ³⁾	kW	6 - 12	15 - 20
Pressure of compressed air	bar	5	5
Consumption ³⁾	(m ³ /h)	10 - 20	10 - 20
Coolant system	l	850	850
Approx. weight of machine ³⁾	kg	1900	2900
Max dimensions L x D x H in m	m	2.85 x 1.53 x 2.75	4.0 x 2.2 x 3.0
when machining from wire	m	1 + 2	1 + 2

¹⁾ On each station, two of three possible machining axis can be equipped with a machining station.

²⁾ Other voltages require a transformer (optional).

³⁾ Is affected by the number of units.

The technical data listed are not binding and may be changed at any time without notice.

Mikron Machining

Mikron Switzerland AG, Agno **Division Machining**

Headquarter
Via Ginnasio 17
6982 Agno
Switzerland
Tel. +41 91 610 61 11
Fax +41 91 610 66 80
mag@mikron.com

Mikron Germany GmbH

Berner Feld 71
D-78628 Rottweil
Tel. +49 741 5380 0
Fax +49 741 5380 580
mro@mikron.com

Mikron Corp. Monroe

200 Main Street
P.O. Box 268
Monroe, CT 06468 / USA
Tel. +1 203 261 31 00
Fax +1 203 268 47 52
mmo@mikron.com

