

# Case History Mikron miTool

The next level of tool monitoring

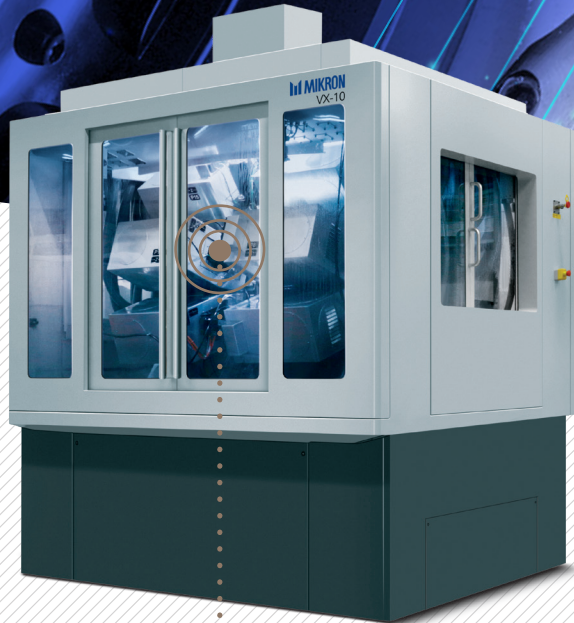

High precision and high-volume part production on Mikron high performance systems involve sophisticated machining processes. Advanced Tool monitoring becomes crucial to avoid unexpected machine downtime, machine breakage, tool damage, material scrap and the likely issues. Surface finish, tolerances and machine efficiency can be improved.

# Case History Mikron miTool

on Mikron VX

With the introduction of Mikron miTool - the next level in tool monitoring, we offer our customers finally a more powerful, easy way of tool monitoring with innovative features, so you get the most out of your Mikron high performance system.

## THE CHALLENGE

The customer produces 6.13 mio parts per year (OEE 80%) for the automobile industry on Mikron VX.  
**Target:** Reduce tooling costs, improve part quality and increase machine efficiency.

Productivity	17.4 Pc/min
Daily working time	1'440 min/day
Annual working days	306 days/year

OEE		OEE 80%	
25'056	Pc/day	20'045	Pc/day
150'336	Pc/week	120'269	Pc/week
7'667'136	Pc/year	6'133'709	Pc/year

## CUTTING TOOL MONITORED WITH Mikron miTool STATION 5 (SEE DRAWING):

Cutting tool costs 211.00 chf/Cutting tool

Tool wear deteriorates the part quality and can generate vibrations for the other machining units.

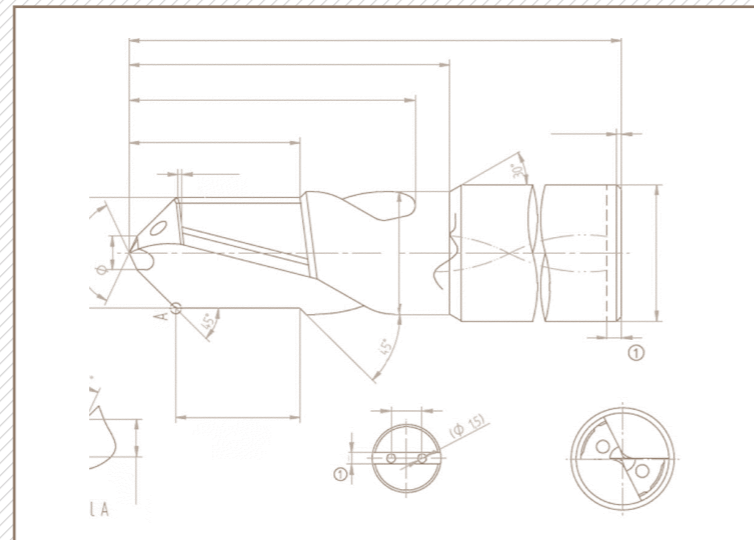

## EXISTING / TRADITIONAL TOOL MONITORING

### STATION 5

Tooling costs per year

<b>TOOL LIFE 10'000 PC</b>	
N°. of tools per day	2
N°. of tools per week	12
N°. of tools per year	613

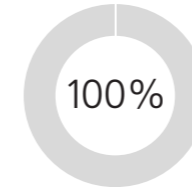

Time to change the cutting tool

<b>TOOL LIFE 10'000 PC</b>	
Time for tool change per day	10 minutes
Time for tool change per week	60 minutes
Time for tool change per year	3'067 minutes

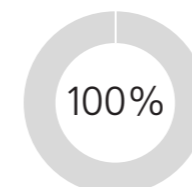

## TOOL MONITORING WITH Mikron miTool

### STATION 5

Tooling costs per year

<b>TOOL LIFE 14'000 PC</b>	
N°. of tools per day	1.4
N°. of tools per week	8.6
N°. of tools per year	438

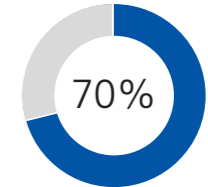

Approx **37.000 CHF** savings / year with one cutting tool monitored (cutting tool cost/pc 211.00 CHF)

Savings on time to change the cutting tool

<b>TOOL LIFE 14'000 PC</b>	
Time for tool change per day	7 minutes
Time for tool change per week	43 minutes
Time for tool change per year	2'191 minutes
Δ daily	-3 minutes
Δ weekly	-17 minutes
Δ yearly	-876 minutes

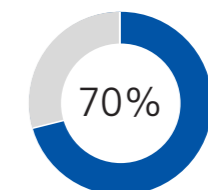

The machine is **876 min** more in production

# Mikron miTool

The next level of tool monitoring

## Mikron miTool IS EASY TO INSTALL AND CUSTOMERS BENEFIT GREATLY IN TERMS OF EFFICIENCY AND EXPENDITURE.

- » Prevention of damage due to tool breakage or tool overload
- » Sensorless with automated learning of load limits (Option to integrate vibration and temperature sensors)
- » For turning, milling and drilling and smallest tool sizes (up to 1.5 mm diameter)
- » Powerful algorithm for efficient monitoring after the first workpiece. It has a built-in learning function, allowing it to compensate for differences in processes.
- » The system maximizes the service lives of both the tools and Mikron high performance machines

Attractive pricing and fast return on invest

### WHAT MAKES Mikron miTool SO SPECIAL FOR YOU

- » Highest sensibility and quality of data points deliver the finest and exact monitoring curves
- » Intuitive icon driven graphical interface for easiest use and monitoring by operators
- » Intelligent algorithm for advanced process optimization and cutting tool wear identification
- » Mikron miTool is able to storage data and history for each tool configuration and monitoring curve
- » Dashboard with statistical overview for each tool allows the optimization of the entire production process
- » Mikron miTool permits all modifications (set up, regulations...) without machine stop
- » Automatic actions programmable for each channel e.g. save data in database, send notification, preventively stop the machine
- » Perfectly integrated into Mikron high performance systems

Intelligent powerful algorithm for optimal intervals to change several cutting tools at the same time leads to higher machine efficiency and economy (less machine stops).

### 5 CUTTING TOOLS CHANGED AT 5 STOPS

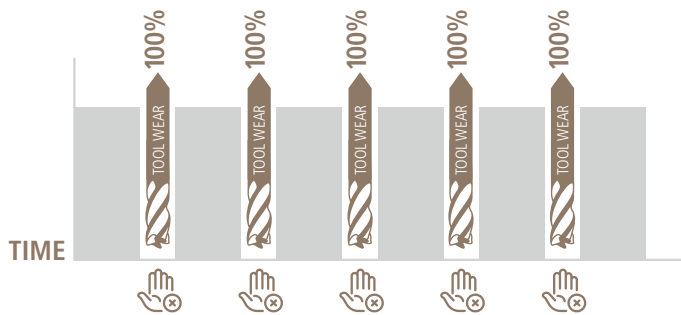

Number of machine stops for cutting tool changes

### 5 CUTTING TOOLS CHANGED AT 1 STOP

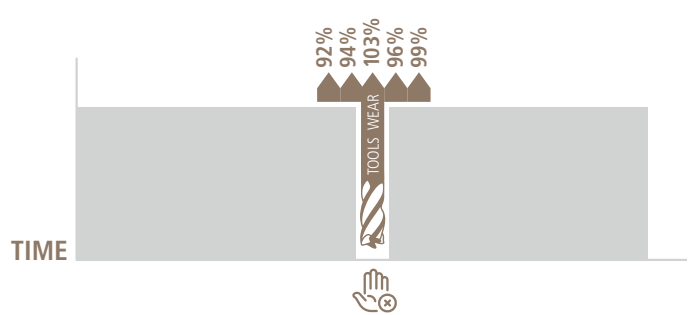

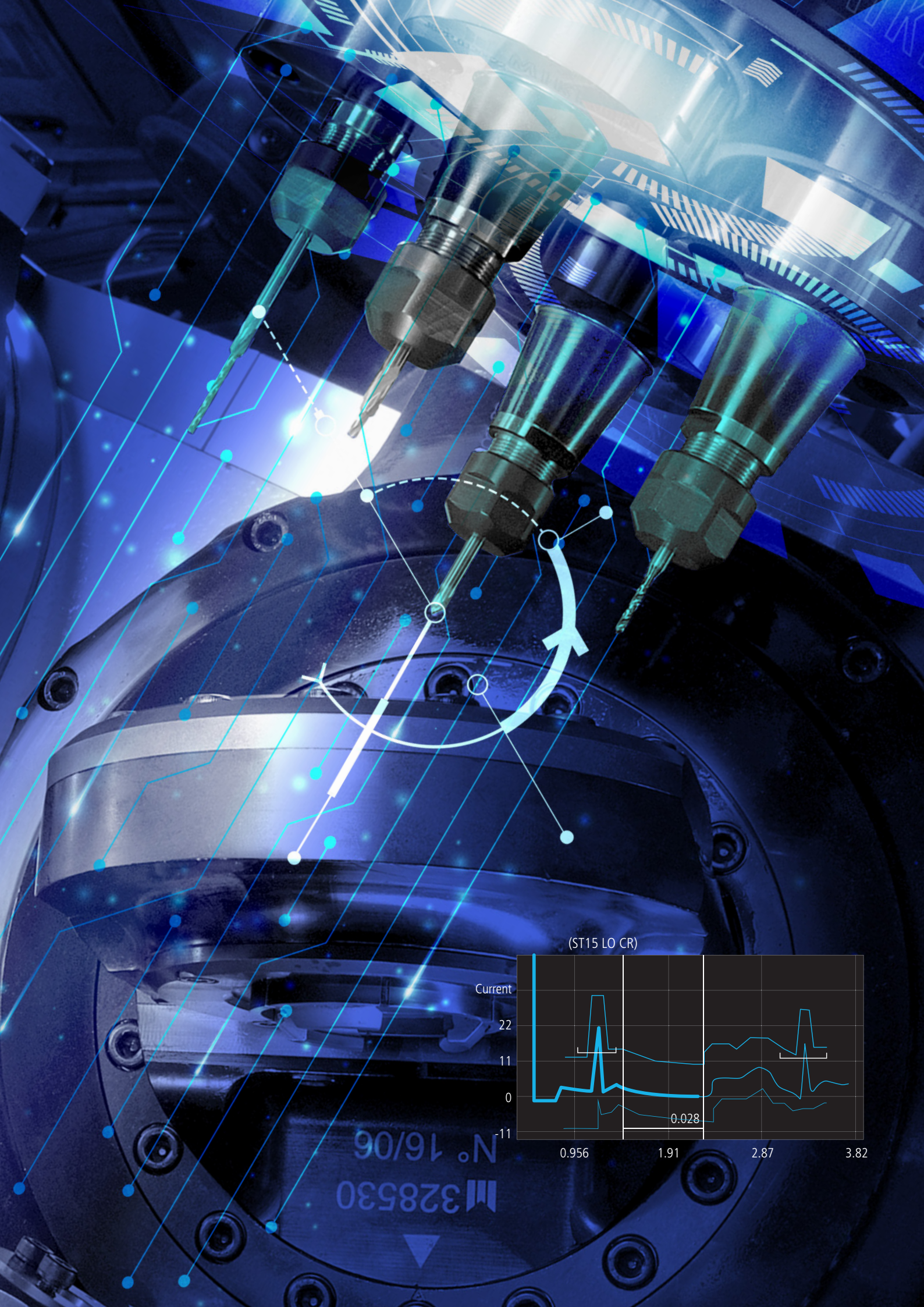

(ST15 LO CR)

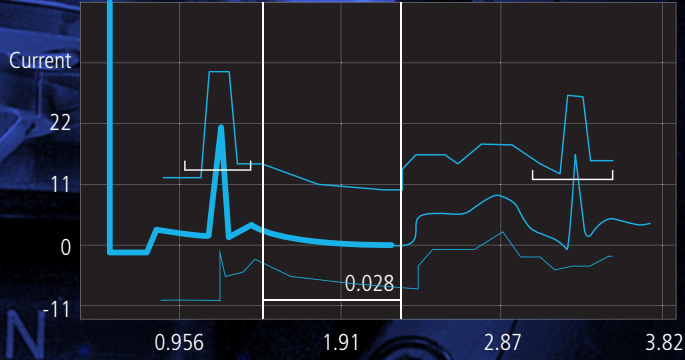

N° 16/06  
328530

# Mikron miTool - a miS4.0 product

The next level of tool monitoring

## MIKRON miTool INTERFACE - GENERAL OVERVIEW

Parallel and time independent monitoring of up to 200 channels

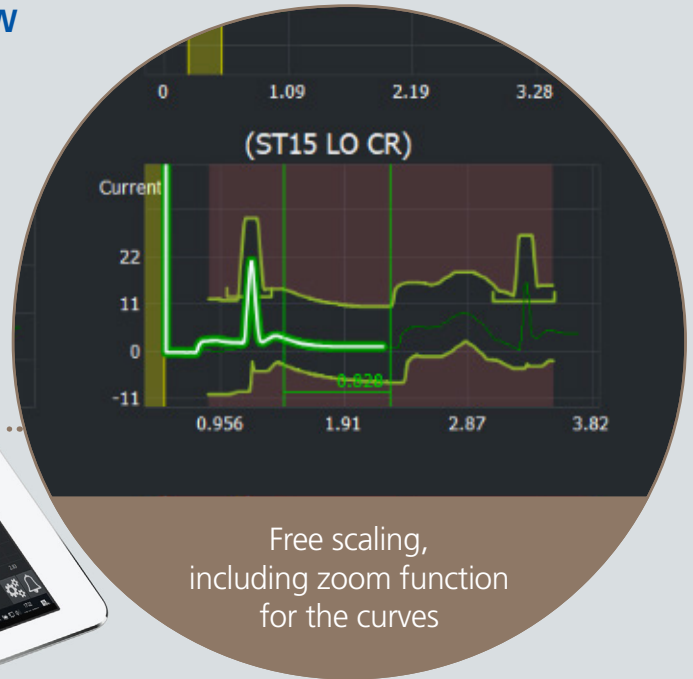

Free scaling, including zoom function for the curves

Intelligent menu driven user interface easy to operate

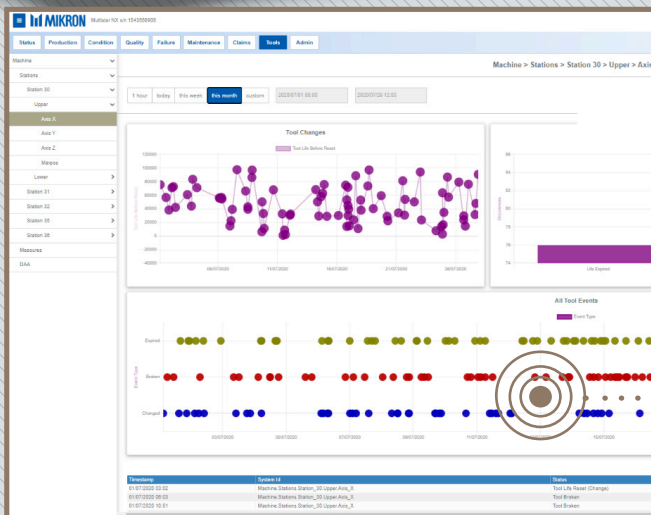

Easy monitoring with Mikron miTool dashboard in a simple and independent way by a common web browser. For the optimization of the entire production process all statistical data are available (number of tool changes, number of broken or life expired tools)

Contact your Service Center today. We gladly be of assistance.

Germany  
**Service Center**  
Tel. +49 741 5380 200  
service.mro@mikron.com  
OH: 08.00 - 17.30

Switzerland  
**Service Center**  
Tel. +41 91 610 61 61  
service.mag@mikron.com  
OH: 08.00 - 17.30

USA/Canada  
**Service Center**  
Tel. +1 203 261 31 00  
service.mmo@mikron.com  
OH: 7.30 am - 5.00 pm EST

China  
**Service Center**  
Tel. +86 1592 1577 050  
services.mm.msh@mikron.com  
OH: 08.00 - 17.30

